



HAL
open science

Model-free control and fault accommodation for an experimental greenhouse

Frédéric Lafont, Jean-François Balmat, Nathalie Pessel, Michel Fliess

► **To cite this version:**

Frédéric Lafont, Jean-François Balmat, Nathalie Pessel, Michel Fliess. Model-free control and fault accommodation for an experimental greenhouse. International Conference on Green Energy and Environmental Engineering (GEEE-2014), May 2014, Sousse, Tunisia. 7 p. hal-00978226v2

HAL Id: hal-00978226

<https://polytechnique.hal.science/hal-00978226v2>

Submitted on 10 Jul 2014

HAL is a multi-disciplinary open access archive for the deposit and dissemination of scientific research documents, whether they are published or not. The documents may come from teaching and research institutions in France or abroad, or from public or private research centers.

L'archive ouverte pluridisciplinaire **HAL**, est destinée au dépôt et à la diffusion de documents scientifiques de niveau recherche, publiés ou non, émanant des établissements d'enseignement et de recherche français ou étrangers, des laboratoires publics ou privés.

Model-free control and fault accommodation for an experimental greenhouse

Frédéric Lafont^{1,2}, Jean-François Balmat^{1,2}, Nathalie Pessel^{1,2}, Michel Fliess^{3,4}

Abstract—The greenhouse climate control is important in modern agriculture. It is also rather difficult to design: as a matter of fact writing down a “good” mathematical model, which takes into account strong meteorological disturbances, might be an impossible task. The control is here synthesized via a new “model-free” setting, which yields an “intelligent” proportional feedback controller, the tuning of which is straightforward, and even simpler than the intelligent proportional-integral controller, which was already utilized in a previous publication. Our control strategy is successfully tested via an experimental greenhouse. The comparison with the classic Boolean approach, which is popular among manufacturers, demonstrates the superiority of our viewpoint, which permits moreover an efficient actuator fault accommodation. It might be the first model-free fault-tolerant control, which works satisfactorily in practice.

Index Terms—Agriculture, greenhouse control, model-free control, intelligent PID controllers, model-free fault-tolerant control.

I. INTRODUCTION

The literature on the greenhouse climate control, which is becoming more and more important in modern agriculture, is fast growing (see, *e.g.*, the four books [16], [21], [23], [25], and the references therein). Most of the existing control approaches, like adaptive control, predictive control, optimal control, stochastic control, nonlinear control, partial differential equations, PIDs, on-off control, fuzzy control, neural networks, soft computing, *...*, have been employed and tested (see, *e.g.*, the previous books, the papers [3], [4], [12], [19], and the references therein, for interesting discussions). Let us emphasize that writing down a “good” model, *i.e.*, a model combining simplicity and exactness, is a most difficult task, which has perhaps not yet been, and might never be achieved in a satisfactory way (see [13] for more details and references). This explains why model-based techniques have not been used in practice until now.

This communication develops therefore a new “model-free” setting and the corresponding “intelligent” PIDs [5] which has already been successfully utilized in a number

of concrete case-studies in most diverse fields (the bibliographies in [5], [6] list most of the already published applications). Let us compare it with [13] which was also utilizing the same model-free viewpoint:

- 1) The intelligent proportional-integral controller in [13] is replaced by an intelligent proportional one [5], the tuning of which turns out to be even more straightforward. The performances remain nevertheless excellent as demonstrated by an experimental greenhouse.
- 2) Following [5], an actuator fault is taken into account without further ado. It might be the first time to the best of our knowledge that an efficient model-free fault-tolerant strategy is presented and applied in a concrete situation.

Remark 1.1: The literature on model-based fault diagnosis and fault-tolerant control is huge (see, *e.g.*, [9], [17], [22], and the references therein). The corresponding supervision structure is well summarized by Figure 1, which is borrowed from [9]. Note that this figure would remain almost unchanged in the model-free case. Let us also mention here the significative advances presented in [7], [8], [11], which utilize the same algebraic estimation techniques as in Section II-C.

Our paper is organized as follows. Sections II and III are devoted to brief reviews of model-free control and fault accommodation. Section IV presents our experimental greenhouse system. The intelligent proportional controller is implemented in Section V. A comparison with a Boolean controller is discussed in Section VI. Moreover, to strengthen the evidence for the efficiency of the method, we present results of the controller with different temperature references in Section VII. Section VIII demonstrates the ability of our controller to overcome the presence of an actuator fault. Some concluding remarks may be found in Section IX.

II. MODEL-FREE CONTROL AND INTELLIGENT CONTROLLERS¹

A. The ultra-local model

Let us restrict ourselves to single-input single-output (SISO) systems. The unknown global description of the plant is replaced by the *ultra-local model*:

$$\dot{y} = F + \alpha u \quad (1)$$

¹See [5] for more details.

¹LSIS (UMR CNRS 7296), Université de Toulon, 83957 La Garde, France.

{lafont, balmat, nathalie.pessel}@univ-tln.fr

²LSIS (UMR CNRS 7296), Aix Marseille Université & ENSAM, 13397 Marseille, France.

³LIX (UMR CNRS 7161), École polytechnique, 91128 Palaiseau, France. Michel.Fliess@polytechnique.edu

⁴AL.I.E.N. (ALgèbre pour Identification & Estimation Numériques), 24-30 rue Lionnois, BP 60120, 54003 Nancy, France.

michel.fliess@alien-sas.com

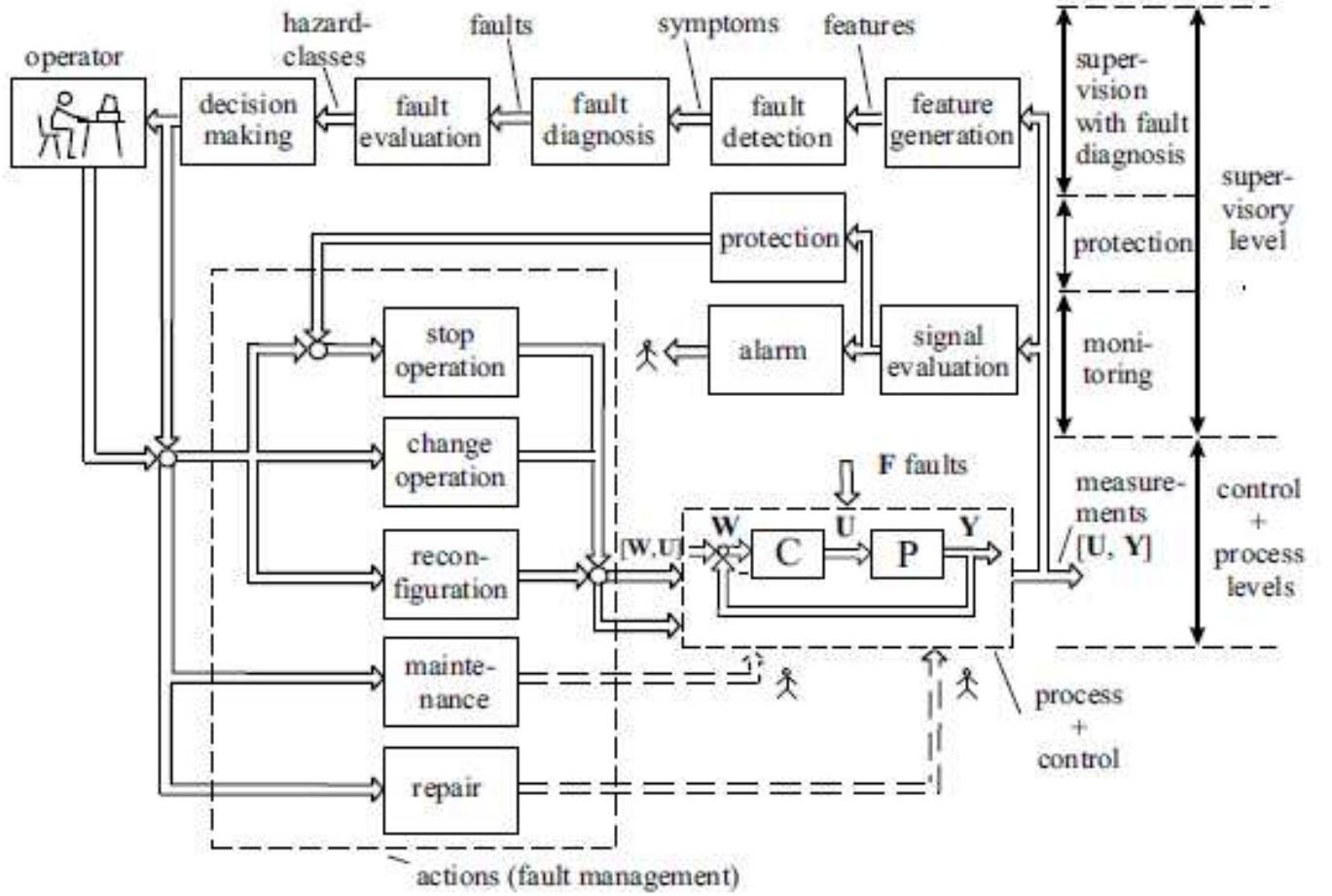

Fig. 1. A supervision structure

where:

- The control and output variables are respectively u and y .
- The derivation order of y is 1 like in most concrete situations.
- $\alpha \in \mathbb{R}$ is chosen by the practitioner such that αu and \dot{y} are of the same magnitude.

The following explanations on F will be useful:

- F is estimated via the measure of u and y .
- F subsumes not only the unknown structure of the system but also of any perturbation.

B. Intelligent controllers

The loop is closed by *intelligent proportional-integral controller*, or *iPI*,

$$u = -\frac{F - \dot{y}^* + K_P e + K_I \int e}{\alpha} \quad (2)$$

where:

- $e = y - y^*$ is the tracking error,
- K_P, K_I are the usual tuning gains.

When $K_I = 0$, we obtain *intelligent proportional controller*, or *iP*,

$$u = -\frac{F - \dot{y}^* + K_P e}{\alpha} \quad (3)$$

Remark 2.1: The iP controller (3) will be used here whereas the iPI (2) was exploited in [13]. Combining Equations (1) and (3) yields:

$$\dot{e} + K_P e = 0$$

where F does not appear anymore. The tuning of K_P is therefore quite straightforward. This is a major benefit when compared to the tuning of “classic” PIDs (see, e.g., [2], [18], and the references therein).

Remark 2.2: Here and in [13] our intelligent controllers are successfully used in an on-off way. This was also the case in [1] for a freeway ramp metering control.

C. Estimation of F

1) *First approach:* Assume that F in Equation (1) is “well” approximated by a piecewise constant function F_{est} . Rewrite then Equation (1) in the operational domain (see, e.g., [24]):

$$sY = \frac{\Phi}{s} + \alpha U + y(0)$$

where Φ is a constant. We get rid of the initial condition $y(0)$ by multiplying both sides on the left by $\frac{d}{ds}$:

$$Y + s \frac{dY}{ds} = -\frac{\Phi}{s^2} + \alpha \frac{dU}{ds}$$

Noise attenuation is achieved by multiplying both sides on the left by s^{-2} . It yields in the time domain the realtime estimate, thanks to the equivalence between $\frac{d}{ds}$ and the multiplication by $-t$,

$$F_{\text{est}}(t) = -\frac{6}{\tau^3} \int_{t-\tau}^t [(\tau - 2\sigma)y(\sigma) + \alpha\sigma(\tau - \sigma)u(\sigma)] d\sigma$$

where $\tau > 0$ might be quite small. This integral, which is a low pass filter, may of course be replaced in practice by a classic digital filter.

2) *Second approach:* Close the loop with the iP (3). It yields:

$$F_{\text{est}}(t) = \frac{1}{\tau} \left[\int_{t-\tau}^t (\dot{y}^* - \alpha u - K_{PE}) d\sigma \right]$$

Remark 2.3: Let us emphasize that implementing our intelligent controllers is easy (see [5], [10]).

III. ACTUATOR'S FAULT ACCOMMODATION

There are two main ways in order to deal with an actuator fault (see, e.g., [9], [17], [22]):

- 1) The first one is self-tuning, or fault accommodation. It relies on an on-line control law that preserves the main performances, while some minor parts may slightly deteriorate.
- 2) The second one is self-organization where faulty components are replaced.

We only consider here fault accommodation.

Express the actuator fault via

$$u_r = u(1 - \beta) \quad (4)$$

where

- β , $0 < \beta < 1$, is the loss of efficiency of the actuator;
- u_r is the true control variable.

The two following cases are not considered:

- $\beta = 0$ means that there is no fault.
- $\beta = 1$ implies that the control does not act anymore.

Then Equation (1) becomes

$$\dot{y} = \bar{F} + \alpha u$$

where

$$\bar{F} = F - \alpha\beta u$$

Fault accommodation is then achieved by estimating \bar{F} as in Section II-C.

Remark 3.1: It is clear that β does not need to be a constant. It may be time-dependent.

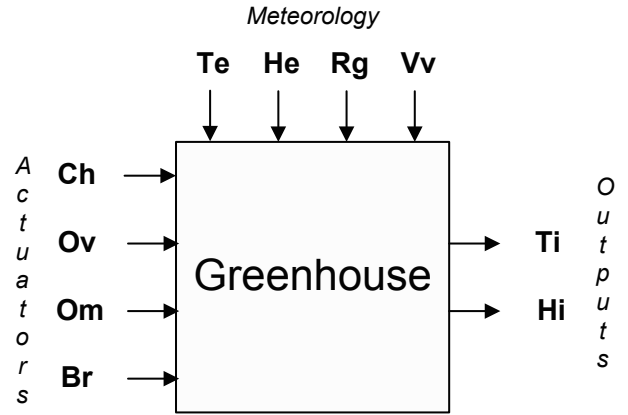

Fig. 3. System variables

IV. APPLICATION: EXPERIMENTAL GREENHOUSE

Figure 2 shows our experimental plastic greenhouse which is manufactured by the French company *Richel*. It is located in Toulon and is the property of the *Laboratoire des Sciences de l'Information et des Systèmes*, to which the first three authors belong. Its area is equal to 80 m². This experimental greenhouse is controlled by a microcomputer and interfaced with the FieldPoint FP-2000 network module developed by the American company *National Instruments Corporation*. The FP-2000 network module is associated with two analog input modules (FP-AI-110, FP-AI-111), for the acquisition, and two relay output modules (FP-RLY-420), for the control. The acquisition and control system is developed with the *LabView* language. The sampling period is equal to 1 minute. The inside air temperature and humidity are controlled.

A. Description of the system

The greenhouse is a multi-input and multi-output (MIMO) system which is equipped with several sensors and actuators (see Figure 3).

There are four actuators (heating (thermal power 58 kw) Ch (*Boolean*), opening (50 % max) Ov (%), shade Om (%), fog system Br (*Boolean*)), four meteorology disturbances sensors (External temperature Te ($^{\circ}C$), external hygrometry He (%), solar radiation Rg (W/m^2), speed of the wind Vv (km/h)) and two internal climate sensors (internal temperature Ti ($^{\circ}C$), internal hygrometry Hi (%)). This system is moreover nonstationary and strongly disturbed. Indeed, the solar radiation has a very high power during a day and can change the internal greenhouse climate.

B. Climate management

In the greenhouse system, the temperature and hygrometry management are treated together, because these two quantities are strongly correlated:

- The heating has a dehumidifier effect.
- The opening system has a cooling and dehumidifier effect.
- The fog system has a cooling effect.



Fig. 2. Our experimental greenhouse system

Controlling the temperature and the hygrometry is therefore of utmost importance.

1) *Hygrometry reference*: There is no real recommendations by species. It appears nevertheless that

- for the multiplication phase, the hygrometry must be greater than 80 %,
- for the growth phase, the reference is comprised between 60 and 80 %,
- for the tomato, the reference is rather comprised between 50 and 70 %.

Here are some other advices:

- avoid condensations,
- avoid a humidity level close to saturation (100 %),
- avoid a humidity level below 40 % for seedlings,
- absolutely avoid a hygrometry below 20 %.

2) *Temperature reference*: The difficulties for tuning an efficient controller may be attributed to the following causes:

- various references
 - in a day,
 - according to the species;
- system parameter variations according to the plant growth.

Note the difficulty to use an unique “good” model and therefore, for our application, the interest of model-free control. We specify that due to a lack of space we only present here internal temperature results. Hygrometry, which is also well regulated, will be reported elsewhere (see also [13]).

TABLE I
SETTING VALUES

Variable	Value
δ	6 minutes
α	1
K_P	2

V. RESULTS

An iP (3) is implemented for regulation of the temperature.

A. Temperature

The estimation $F_{\text{approx}}^{\text{temp}}$ is given by

$$F_{\text{approx}}^{\text{temp}} = \frac{1}{\delta} \int_{T-\delta}^T \left(-\alpha Ch + \dot{T}_i^* - K_P e T_i \right) d\tau \quad (5)$$

B. Setting values

The controller Ch is deduced from Equations (1), (3) and (5). This controller is a *Pulse Width Modulation*, or *PWM*, controller. Table I displays the setting values for the controller.

The reference output is 18°C for the temperature with a tolerance equal to 0.5°C . The simulation lasts 12 hours, from 8:00 pm until 8:00 am. We choose the night in order to compare the obtained results with Boolean control (see Section VI) in similar weather conditions.

Figure 4 shows the internal/external temperature evolution during the night of February 20th – 21th, 2014.

Figure 5 shows the control sequences for heating. Observe that the heating control allows the internal temperature T_i to be closed to the reference output.

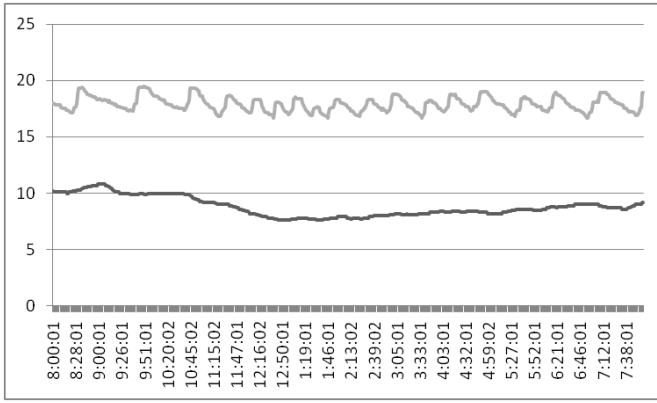

Fig. 4. Internal temperature with model-free control (Te: black line - Ti: grey line)

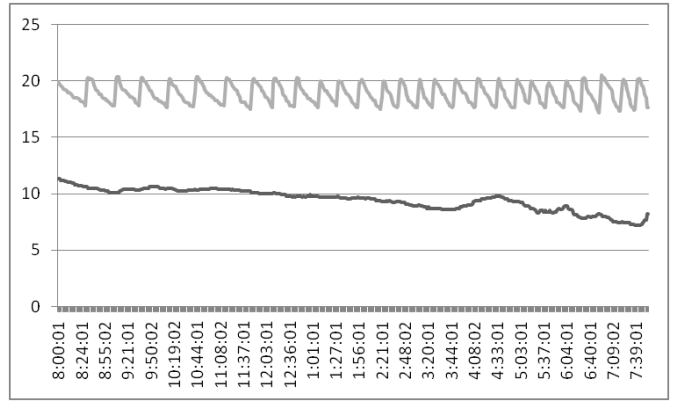

Fig. 6. Internal temperature with a Boolean controller (Te: Black line - Ti: Grey line)

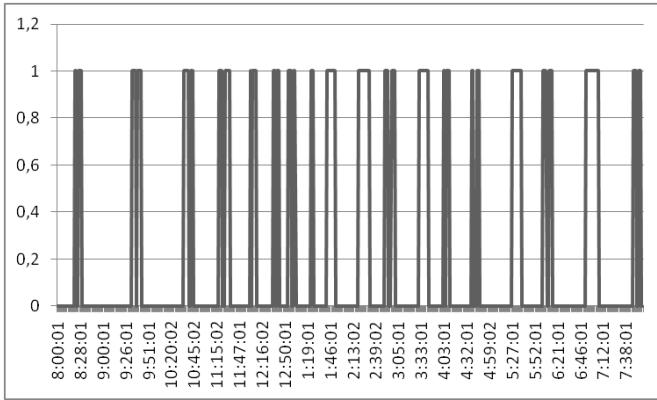

Fig. 5. Heating control with model-free control

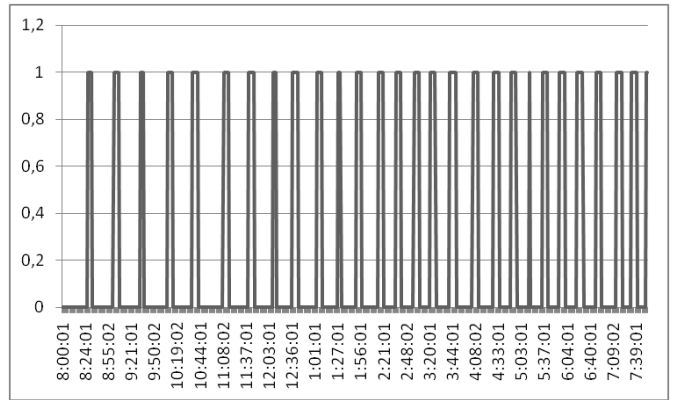

Fig. 7. Heating control with a Boolean controller

TABLE II
RESULTS EVALUATION

Method	mean	variance
Model-free control e_{T_i}	-0.1°	0.4°
Classic Boolean control e_{T_i}	0.8°	0.7°

TABLE III
COMPARISONS OF THE ENERGY

Actuator	Model-free control	Classical Boolean control
Heat	143 min	145 min

VI. SOME COMPARISONS

A classic Boolean control law with threshold is employed for the comparisons. This type of elementary technique is quite popular in agriculture. Experiments have been carried on during two different nights, *i.e.*, February 20th – 21th and 21th – 22th, 2014, respectively for the model-free and Boolean settings. The temperature reference output is 18°C with a tolerance equal to 0.5°C, as in Section V.

- Figures 6 and 7 show respectively results for the internal temperature and for the Boolean control during the night of 21th – 22th, 2014.
- Table II shows the mean and the variance of the error between T_i and the output reference of T_i for the two controllers.
- Table II demonstrates that our model-free control strategy behaves better than its Boolean counterpart. Let us emphasize two more points:

- As already explained in Section IV, one of the goals of climate control is to reduce the energy consumption. Table III shows that the heating is on only about 20% of the time with the model-free setting. Observe that the model-free control is consuming less than its Boolean counterpart.
- For a given operating time, the model-free control ensures a better tracking of the reference signal.

VII. REFERENCE CHANGE

Figure 8 shows results for the internal temperature with a reference change. Figure 9 represents the corresponding heating control. We regulate the greenhouse with the temperature reference output equal to 20°C during the night of February 11th – 12th, 2014.

Figure 10 shows results for the internal temperature with another reference change. Figure 11 represents the corresponding heating control. We regulate the greenhouse with

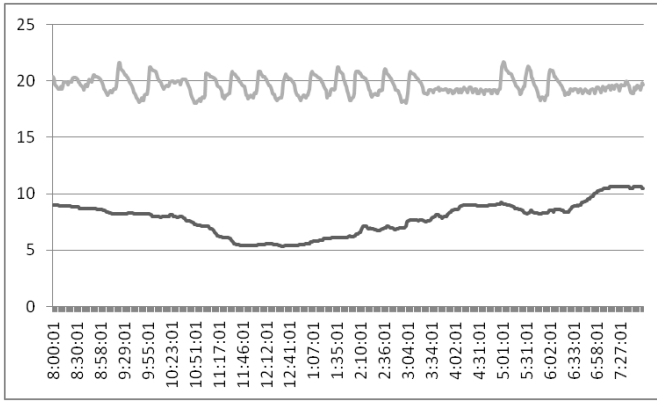

Fig. 8. Internal temperature with model-free control (Te: Black line - Ti: Grey line)

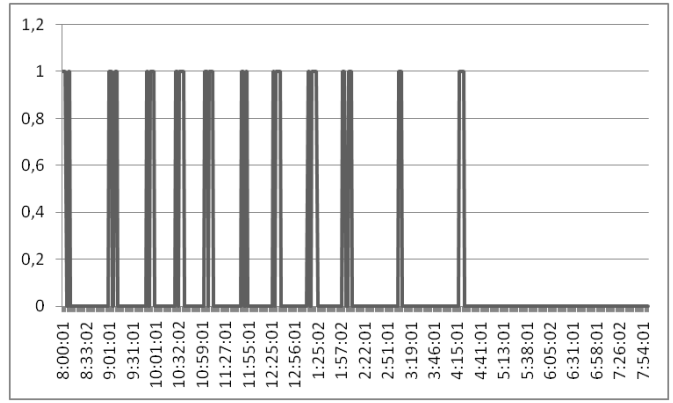

Fig. 11. Heating control with model-free control

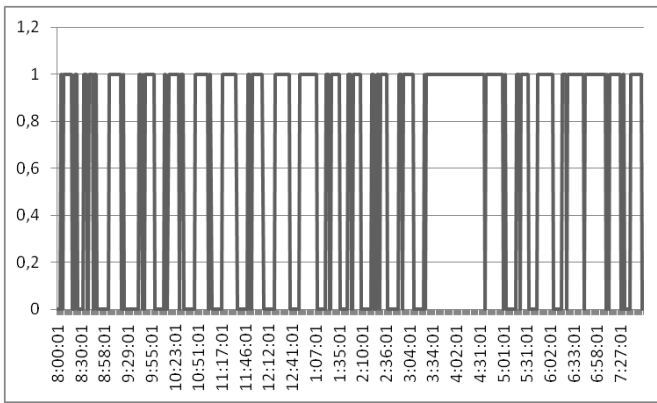

Fig. 9. Heating control with model-free control

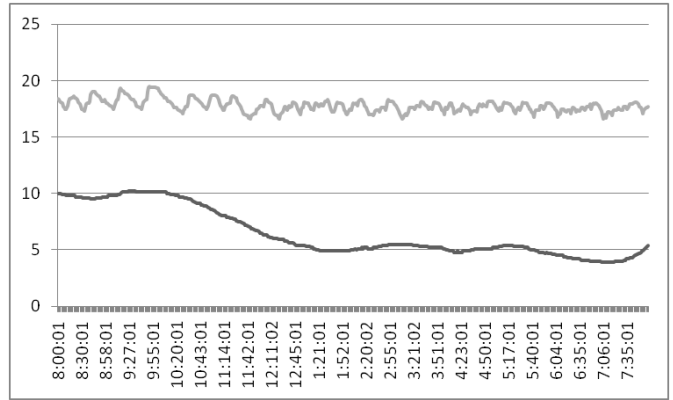

Fig. 12. Internal temperature with model-free control (Te: Black line - Ti: Grey line)

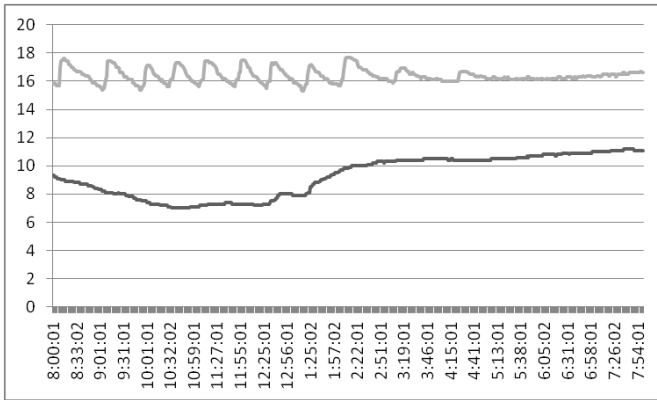

Fig. 10. Internal temperature with model-free control (Te: Black line - Ti: Grey line)

the temperature reference output equal to 16°C during the night of February $17^{\text{th}} - 18^{\text{th}}$, 2014.

Note that model-free control results are close to the reference output, whatever it is. As already pointed in Section IV-B, this is a most significant advance. It is moreover achieved without any new calibration of our iP controller.

VIII. FAULT-TOLERANT CONTROL

Following the calculations sketched in Section III with a loss of 50% of the actuator's efficiency, *i.e.*, $\beta = 0.5$, Figure 12 displays results for the internal temperature with the temperature reference output equal to 18°C during the night of February $12^{\text{th}} - 13^{\text{th}}$, 2014. Figure 13 represents the corresponding heating control. The output temperature does not reach the temperature reference output perfectly. It remains nevertheless very close to it despite the external temperature and the importance of the fault. This is a quite remarkable achievement.

Figure 14 confirms the previous results: for the same reference temperature and during the night of February $13^{\text{th}} - 14^{\text{th}}$, 2014, β is now equal to 0.25. Figure 15 represents the corresponding heating control. The output temperature becomes even closer to the reference output.

IX. CONCLUSION

The communication, which improves a previous one [13] by utilizing a simpler feedback loop and by introducing a model-free fault-tolerant control, may certainly be completed, for instance by further investigating fault diagnosis (see, *e.g.*, [14], [20] for other viewpoints) and fault accommodation. Several components of Figure 1 need indeed to be analyzed in our context. Testing our control strategy with

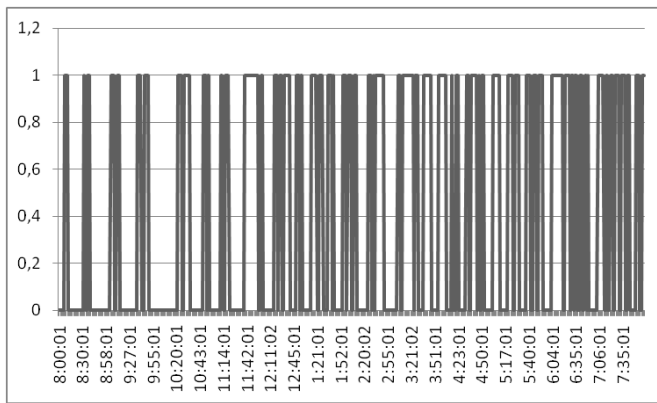

Fig. 13. Heating control with model-free control

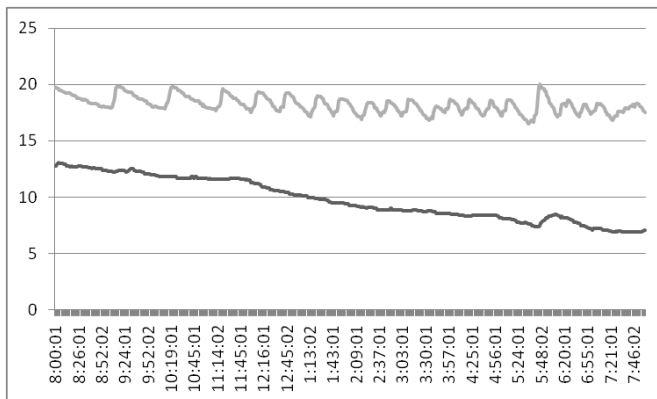

Fig. 14. Internal temperature with model-free control (Te: Black line - Ti: Grey line)

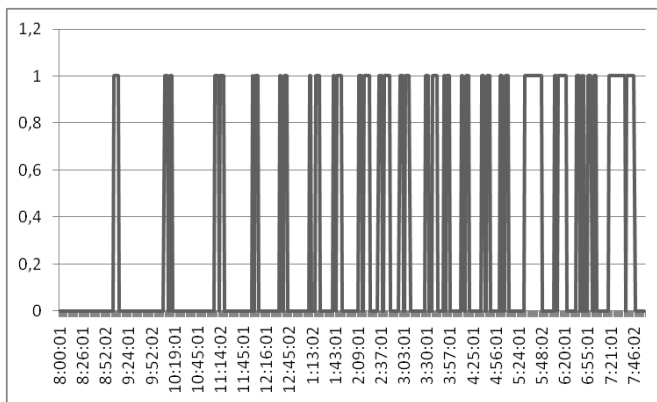

Fig. 15. Heating control with model-free control

more advanced greenhouse systems would most certainly further enhance the capabilities of our approach. We also hope that similar techniques might be useful in more or less analogous domains like air-conditioning in buildings (see, e.g., [15]).

ACKNOWLEDGEMENT

This work was partially supported by the *Institut Universitaire de Technologie de Toulon*, France. One author (M.F.) would like to thank Dr. C. Join for several helpful

discussions.

REFERENCES

- [1] H. Abouaïssa, M. Fliess, V. Iordanova, C. Join, Freeway ramp metering control made easy and efficient, *13th IFAC Symp. Control Transportation Systems*, Sofia, 2012. Available at <http://hal.archives-ouvertes.fr/hal-00711847/en/>
- [2] K.J. Åström, T. Hägglund, *Advanced PID Control*, Instrument Soc. Amer., 2006.
- [3] D.L. Critten, B.J. Bailey, A review of greenhouse engineering developments during the 1990s, *Agric. Forest Meteorology*, 112, 1-22, 2002.
- [4] C. Duarte-Galvan, I. Torres-Pacheco, R.G. Guevara-Gonzalez, R.J. Romero-Troncoso, L.M. Contreras-Medina, M.A. Rios-Alcaraz, J.R. Millan-Almaraz, Advantages and disadvantages of control theories applied in greenhouse climate control systems, *Spanish J. Agri. Res.*, 10, 926-938, 2012.
- [5] M. Fliess, C. Join, Model-free control, *Int. J. Contr.*, 86, 2228-2252, 2013. Available at <http://hal.archives-ouvertes.fr/hal-00828135/en/>
- [6] M. Fliess, C. Join, Stability margins and model-free control: A first look, *13th Europ. Contr. Conf.*, Strasbourg, 2014. Available at <http://hal.archives-ouvertes.fr/hal-00966107/en/>
- [7] M. Fliess, C. Join, H. Sira-Ramírez, Robust residual generation for linear fault diagnosis: an algebraic setting with examples, *Int. J. Contr.*, 77, 1223-1242, 2004.
- [8] M. Fliess, C. Join, H. Sira-Ramírez, Non-linear estimation is easy, *Int. J. Model. Identif. Contr.*, 4, 12-27, 2008. Available at <http://hal.archives-ouvertes.fr/inria-00158855/en/>
- [9] R. Isermann, *Fault-Diagnosis Applications*, Springer, 2011.
- [10] C. Join, F. Chaxel, M. Fliess, "Intelligent" controllers on cheap and small programmable devices, *2nd Int. Conf. Contr. Fault-Tolerant Syst.*, Nice, 2013. Available at <http://hal.archives-ouvertes.fr/hal-00845795/en/>
- [11] L. Kiltz, C. Join, M. Mboup, J. Rudolph, Fault-tolerant control based on algebraic derivative estimation applied on a magnetically supported plate, *Contr. Engin. Practice*, 26, 107-115, 2014.
- [12] F. Lafont, J. F. Balmat, Optimized fuzzy control of a greenhouse, *Fuzzy Sets Syst.*, 128, 47-59, 2002.
- [13] F. Lafont, N. Pessel, J. F. Balmat, M. Fliess, On the model-free control of an experimental greenhouse, *Int. Conf. Model. Simul. Contr.*, San Francisco, 2013. Available at <http://hal.archives-ouvertes.fr/hal-00831598/en/>
- [14] R. Linker, P.O. Gutman, I. Seginer, Observer-based robust failure detection and isolation in greenhouses, *Contr. Engin. Practice*, 10, 519-531, 2002.
- [15] X. Liu, Y. Jiang, T. Zhang, *Temperature and Humidity Independent Control (THIC) of Air-conditioning System*, Springer, 2013.
- [16] A. Medjber, *Automatisation d'une serre agricole: Commande et régulation*, Édit. Univ. Europ., 2012.
- [17] H. Noura, D. Theilliol, J.-C. Ponsart, A. Chamseddine, *Fault-tolerant Control Systems: Design and Practical Applications*, Springer, 2009.
- [18] A. O'Dwyer, *Handbook of PI and PID Controller Tuning Rules* (3rd ed.), World Scientific, 2009.
- [19] N. Pessel, J.F. Balmat, Principal component analysis to the modelling of systems - Application to an experimental greenhouse, *3rd IEEE Int. Conf. Syst. Signals Devices*, Sousse, 2005.
- [20] N. Pessel, J. F. Balmat, F. Lafont, J. Bonnal, Neuronal principal component analysis for the diagnosis of a non-linear system, *15th Medit. Conf. Contr. Automat.*, Athens, 2007.
- [21] P. Ponce, A. Molina, P. Cepeda, E. Lugo, *Greenhouse Design and Control*, CRC Press, 2014.
- [22] A. Shumsky, A. Zhirabok, B. Jiang, Fault accommodation in nonlinear and linear dynamic systems: Fault decoupling based approach, *Int. J. Innovat. Comput. Informat. Contr.*, 7, 4535-4549, 2011.
- [23] L. Urban, I. Urban, *La production sous serre*, t. 1: *La gestion du climat*, 2^e éd., TEC & DOC - Lavoisier, 2010.
- [24] K. Yosida, *Operational Calculus* (translated from the Japanese), Springer, 1984.
- [25] C. von Zabeltitz, *Integrated Greenhouse Systems for Mild Climates*, Springer, 2011.