



**HAL**  
open science

## A simple but energy-efficient HVAC control synthesis for data centers

Michel Fliess, Cédric Join, Maria Bekcheva, Alireza Moradi, Hugues Mounier

► **To cite this version:**

Michel Fliess, Cédric Join, Maria Bekcheva, Alireza Moradi, Hugues Mounier. A simple but energy-efficient HVAC control synthesis for data centers. 3rd International Conference on Control, Automation and Diagnosis, ICCAD'19, Jul 2019, Grenoble, France. 10.1109/iccad46983.2019.9037900 . hal-02125159

**HAL Id: hal-02125159**

**<https://polytechnique.hal.science/hal-02125159>**

Submitted on 10 May 2019

**HAL** is a multi-disciplinary open access archive for the deposit and dissemination of scientific research documents, whether they are published or not. The documents may come from teaching and research institutions in France or abroad, or from public or private research centers.

L'archive ouverte pluridisciplinaire **HAL**, est destinée au dépôt et à la diffusion de documents scientifiques de niveau recherche, publiés ou non, émanant des établissements d'enseignement et de recherche français ou étrangers, des laboratoires publics ou privés.

# A simple but energy-efficient HVAC control synthesis for data centers

Michel Fliess<sup>1,3</sup>, Cédric Join<sup>2,3</sup>, Maria Bekcheva<sup>4</sup>, Alireza Moradi<sup>4</sup>, Hugues Mounier<sup>5</sup>

**Abstract**—The air conditioning management of data centers, a key question with respect to energy saving, is here tackled via the recent model-free control synthesis. Mathematical modeling becomes useless in this approach. The tuning of the corresponding intelligent proportional controller is straightforward. Computer simulations show excellent tracking performances in various realistic situations, like CPU load or temperature changes.

**Key words**—Data centers, cloud computing, HVAC, PID, model-free control, intelligent proportional controller, tracking.

## I. INTRODUCTION

Two exciting advances in cloud computing [2], a fast growing industry in information technology, have been recently derived by the authors:

- improving resource elasticity [7] thanks to model-free control in the sense of [17],
- workload forecasting [18] via time series analysis as in [20].

Data centers, which are fundamental in this context, consume a huge amount of electrical energy [8], [27], [44]. Almost half of it is devoted to their cooling. The aim of this communication is to show that model-free control might provide also a most efficient control tool with respect to air conditioning.

*Remark 1:* 1) HVAC, i.e., heating, ventilation, and air conditioning, which is defined by Wikipedia as “the technology of indoor and vehicular environmental comfort” (see, e.g., [29]), plays therefore a key rôle (see, e.g., [11], [28]). The corresponding numbers of publications and patents are increasing rapidly.

2) From an applied control engineering perspective, on/off and PID controllers seem to be widely used (see, e.g., [9], [14], [15], [32], [37], [40], and the references therein). To a large extent this situation is explained by their conceptual simplicity. Nevertheless their tuning, which is too often a quagmire, might lead to poor performances.

<sup>1</sup>LIX (CNRS, UMR 7161), École polytechnique, 91128 Palaiseau, France, Michel.Fliess@polytechnique.edu

<sup>2</sup>CRAN (CNRS, UMR 7039), Université de Lorraine, BP 239, 54506 Vandœuvre-lès-Nancy, France, cedric.join@univ-lorraine.fr

<sup>3</sup>AL.I.E.N. (ALgèbre pour Identification & Estimation Numériques), 7 rue Maurice Barrès, 54330 Vézelize, France, {michel.fliess, cedric.join}@alien-sas.com

<sup>4</sup>Inagral, 128 rue de la Boétie, 75008 Paris, France, {maria, alireza@inagral.com}

<sup>5</sup>Laboratoire des Signaux et Systèmes (L2S), Université Paris-Sud-CNRS-CentraleSupélec, Université Paris-Saclay, 91192 Gif-sur-Yvette, France, hugues.mounier@l2s.centralesupelec.fr

3) Most of the model-based approaches rest on various optimization techniques (see, e.g., [6], [12], [26], [34], [38], [43]). Let us add that predictive control (see, e.g., [13], [16], [31], [35], [36], [41], [45]) is essential in that respect. Deriving sound mathematical modeling necessitates complex parameter identification and/or machine learning procedures in order to get convincing results (see, e.g., [21]).

*Remark 2:* Besides excellent existing results on the HVAC of greenhouses [30] and buildings [1], [5], [33], [39], model-free control has already given birth to many successful concrete applications (see the references in [17] and [4], [22]) including some patents.

Our paper is organized as follows. Model-free control is summarized in Section II. A simplified mathematical modeling via ordinary differential equations is sketched in Section III for the purpose of computer simulations. The performances of our control synthesis are presented and discussed in Section IV. Section V is devoted to some concluding remarks.

## II. WHAT IS MODEL-FREE CONTROL?<sup>1</sup>

### A. Generalities

Replace the unknown or poorly known SISO system by *ultra-local* model

$$\dot{y} = F + \alpha u \quad (1)$$

where

- $u$  and  $y$  are the input (control) and output variables,
- the derivation order of  $y$  is 1, like in most concrete situations,
- $\alpha \in \mathbb{R}$  is chosen by the practitioner such that  $\alpha u$  and  $\dot{y}$  are of the same magnitude.

The following explanations on  $F$  might be useful:

- $F$  subsumes the knowledge of any model uncertainties and disturbances,
- $F$  is estimated via the measures of  $u$  and  $y$ .

### B. Intelligent controllers

The loop is closed by an *intelligent proportional controller*, or *iP*,

$$u = -\frac{\hat{F} - \dot{y}^* + K_P e}{\alpha} \quad (2)$$

where

- $\dot{y}^*$  is the reference trajectory,
- $e = y - \dot{y}^*$  is the tracking error,
- $K_P$  is the usual tuning gain.

<sup>1</sup>See [17] for more details.

Combining equations (1) and (2) yields:

$$\dot{e} + K_P e = 0$$

where  $F$  does not appear anymore. Local exponential stability is ensured if  $K_P > 0$ :

- The gain  $K_P$  is thus easily tuned.
- Robustness with respect to different types of disturbances and model uncertainties is achieved.

*Remark 3:* See [17] for a discussion about the equivalence between the iP (2) and proportional-integral controllers (PIs).

### C. Real-time estimation of $F$

The term  $F$  in Equation (1) is estimated in real-time according to recent algebraic identification techniques [19]. It may be assumed to be “well” approximated by a piecewise constant function  $\hat{F}$  (see, e.g., [10]). Rewrite then Equation (1) in the operational domain (see, e.g., [42]):

$$sY = \frac{\Phi}{s} + \alpha U + y(0) \quad (3)$$

where  $\Phi$  is a constant. We get rid of the initial condition  $y(0)$  by multiplying both sides on the left by  $\frac{d}{ds}$ :

$$Y + s \frac{dY}{ds} = -\frac{\Phi}{s^2} + \alpha \frac{dU}{ds} \quad (4)$$

Noise attenuation is achieved by multiplying both sides on the left by  $s^{-2}$ . It yields in the time domain the real-time estimate, thanks to the equivalence between  $\frac{d}{ds}$  and the multiplication by  $-t$ ,

$$\hat{F}(t) = -\frac{6}{\tau^3} \int_{t-\tau}^t [(\tau - 2\sigma)y(\sigma) + \alpha\sigma(\tau - \sigma)u(\sigma)] d\sigma \quad (5)$$

where  $\tau > 0$  might be quite “small.”

## III. A SIMPLE MATHEMATICAL MODEL FOR COMPUTER SIMULATIONS

Our model, which is essential for computer simulations, is to a great extent borrowed from [13]. Figures 1-(a) and 1-(b) represent respectively the server air flow circulation and the simplified data center. Figure 2 is sketching the controller and permits to define various important variables. Basic thermodynamic laws lead to the differential equations

$$\begin{cases} \dot{T}_{IT} = \alpha_{11}P_{IT} - \alpha_{12}(T_{IT} - T_{Rack}) \\ \dot{T}_{Rack} = \alpha_{21}(T_{cAisle} - T_{Rack}) + \alpha_{22}(T_{IT} - T_{Rack}) \\ \dot{T}_{cAisle} = \alpha_{31}(T_{Air,in} - T_{cAisle}) + \alpha_{32}(T_{cAisle} - T_{cWall}) \\ \dot{T}_{cWall} = \alpha_{41}(T_{out} - T_{cWall}) + \alpha_{42}(T_{cWall} - T_{cAisle}) \\ \dot{T}_{hAisle} = \alpha_{51}(T_{Rack} - T_{hAisle}) + \alpha_{52}(T_{hAisle} - T_{hWall}) \\ \dot{T}_{hWall} = \alpha_{61}(T_{out} - T_{hWall}) + \alpha_{62}(T_{hWall} - T_{hAisle}) \end{cases} \quad (6)$$

where

- $P_{IT}$  is the input power which corresponds to the CPU load,
- $T_{Air,in}$  (resp.  $T_{IT}$ ) is the control (resp. output) variable,
- $\alpha_{ij}$  are suitable parameters.

From a classic control-theoretic viewpoint,

- Equations (6) yields a system ( $\Sigma$ ) with a single input  $u = T_{Air,in}$  and a single output  $y = T_{IT}$  (see also Figure 2),
- $P_{IT}$  may be viewed as an external disturbance.

## IV. SOME COMPUTER SIMULATIONS

### A. Basic facts

The following values of the parameters are inspired by [13]:  $\alpha_{11} = 2.7248$ ,  $\alpha_{12} = -32.6975$ ,  $\alpha_{21} = 4.2997 \cdot 10^3$ ,  $\alpha_{22} = 2.9632 \cdot 10^4$ ,  $\alpha_{31} = 537.4670$ ,  $\alpha_{32} = 131.6406$ ,  $\alpha_{41} = 514.2857$ ,  $\alpha_{42} = 153.5354$ ,  $\alpha_{51} = 335.9169$ ,  $\alpha_{52} = 7.7166$ ,  $\alpha_{61} = 12$ ,  $\alpha_{62} = 9.6000$ . Following again [13], the output  $y$  of System ( $\Sigma$ ) is assumed to track the setpoint  $20.9^\circ$  (degree Celsius). In Formulae (1)-(2), set  $\alpha = 10$ ,  $K_p = 1$ . The sampling period is 1 min.

*Remark 4:* Note that forecasting results via time series were used in [13]. They become pointless here.

### B. Four preliminary scenarios

1) *Sudden CPU load change:* Figure 3-(a) exhibits a sudden change of the CPU load  $P_{IT}$ . Figure 3-(d) shows that the setpoint is well tracked.

2) *A more realistic CPU load change:* It is given by Inagral, i.e., the Company to which two authors, M. Bekcheva and A. Moradi, belong, and is depicted in Figure 4-(a). Figures 4-(d) confirms a great tracking.

3) *Sudden temperature change:* Figure 5-(b) exhibits a sudden temperature of the data center temperature  $T_{out}$ . Here again Figure 5-(d) depicts an excellent tracking.

4) *Another reference trajectory:* Some situations may necessitate, contrarily to Section IV-A, to replace the setpoint, i.e., a constant reference trajectory, by a more general one. As demonstrated by Figure 6, the tracking remains exceptional.

### C. Sudden model change

Represent a sudden model change at time  $t = 2.7$  h by multiplying  $\alpha_{21}$ ,  $\alpha_{31}$ ,  $\alpha_{51}$  in Equations (6) by 0.5 and 1.5.<sup>2</sup> If those changes would occur at time  $t = 0$ , they should be interpreted as a model mismatch. The variables  $P_{IT}$  and  $T_{out}$  remain unaltered and constant. Although the model-free control synthesis of Section IV-A remains unchanged, Figures 7 et 8 display excellent performances.

## V. CONCLUSION

The *power usage effectiveness*, or *PUE*, of data centers, although heavily criticized [24], seems to be the only measure for checking the energy saving quality today. It would however be meaningless to try applying this indicator here, in the context of such a paper. Section IV, which demonstrates that the tracking works well in rather stringent conditions, may convince the reader that our approach should be nevertheless quite efficient with respect to energy saving. The most important for future developments is of course the

<sup>2</sup>In accordance with [13], those variations may be justified by the change of a coefficient called  $\kappa$ .

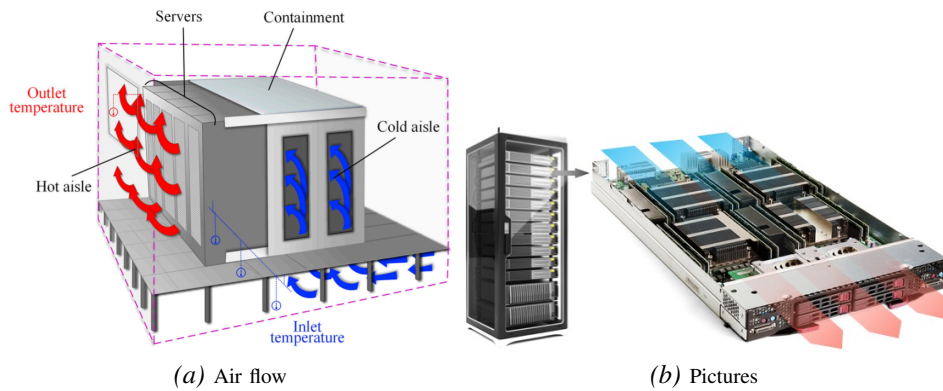

Fig. 1: A simplified data center

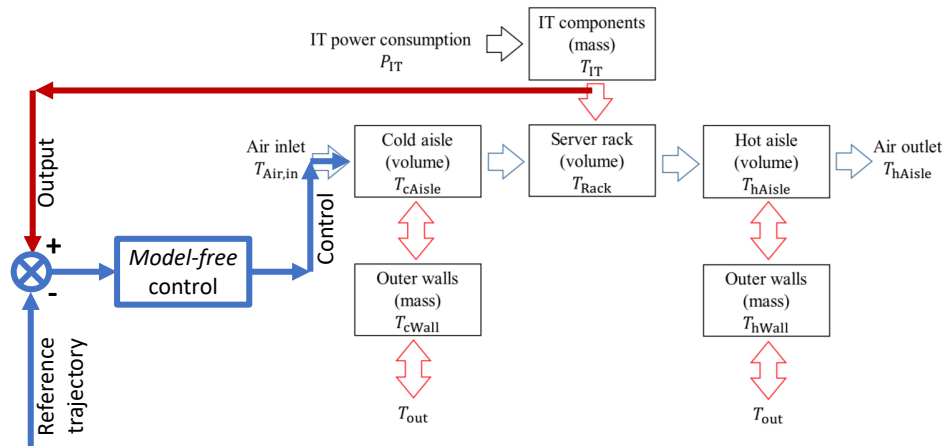

Fig. 2: Control scheme

application of our method to real data. A positive outcome would lead to a critical simplification of the HVAC control management of data centers:

- irrelevance of complex and time-consuming mathematical modeling, which is inherently uncertain,
- forthright tuning.

Promising experiments with a greenhouse [30] and a building [33] comfort this hope. It would confirm thanks also to [7] that model-free control should become important in computer science (compare with [3], [23], [25]).

#### REFERENCES

- [1] H. Abouaïssa, O. Alhaj Hasan, C. Join, M. Fliess, D. Defer, "Energy saving for building heating via a simple and efficient model-free control design: First steps with computer simulations," 21st Int. Conf. Syst. Theor. Contr. Comput., Sinaia, 2017.  
<https://hal.archives-ouvertes.fr/hal-01568899/en/>
- [2] M. Armbrust, A. Fox, R. Griffith, A.D. Joseph, R. Katz, A. Konwinski, G. Lee, D. Patterson, A. Rabkin, I. Stoica, M. Zaharia, "A view on cloud computing," *Comm. ACM*, vol. 53, pp. 50-58, 2010.
- [3] K.J. Åström, R.M. Murray, *Feedback Systems*, Princeton University Press, 2008.
- [4] O. Bara, M. Fliess, C. Join, J. Day, S.M. Djouadi, "Toward a model-free feedback control synthesis for treating acute inflammation," *J. Theoret. Biology*, vol. 448, pp. 26-37, 2018.
- [5] O. Bara, M. Olama, S. Djouadi, T. Kuruganti, M. Fliess, C. Join, "Model-free load control for high penetration of solar photovoltaic generation," 49th North Amer. Power Symp., Morgantown, 2017.  
<https://hal.archives-ouvertes.fr/hal-01558647/en/>
- [6] A. Beghi, L. Cecchinato, G. Dalla Mana, M. Lionello, M. Rampazzo, E. Sisti, "Modelling and control of a free cooling system for data centers," *Energ. Proc.*, vol. 140, pp. 447-457, 2017.
- [7] M. Bekcheva, M. Fliess, C. Join, A. Moradi, H. Mounier, "Meilleure élasticité "nuagique" par commande sans modèle," *ISTE OpenSci. Automat.*, vol. 2. 15 p., 2018.  
<https://hal.archives-ouvertes.fr/hal-01884806/en/>
- [8] A. Beloglazov, J. Abawajy, R. Buyya, "Energy-aware resource allocation heuristics for efficient management of data centers for Cloud computing," *Future Generat. Comput. Syst.*, vol. 28, pp. 755-768, 2012.
- [9] A. Benoît, L. Lefèvre, A.-C. Orgerie, I. Raïs, "Reducing the energy consumption of large scale computing systems through combined shutdown policies with multiple constraints," *Int. J. High Perform. Comput. Appl.*, vol. 32, pp. 176-188, 2018.
- [10] N. Bourbaki, *Fonctions d'une variable réelle*, Hermann, 1976. English translation: *Functions of a Real Variable*, Springer, 2004.
- [11] A. Capozzolia, G. Primiceria, "Cooling systems in data centers: state of art and emerging technologies," *Energy Proc.*, vol. 83, pp. 484-493, 2015.
- [12] C. Conficoni, A. Bartolini, A. Tilli, C. Cavazzoni, L. Benini, "Integrated energy-aware management of supercomputer hybrid cooling systems," *IEEE Trans. Indust. Informat.*, vol. 12, pp. 1299-1311, 2016.
- [13] L. Cupelli, T. Schütz, P. Jahangiri, M. Fuchs, A. Montù, D. Müller, "Data center control strategy for participation in demand response programs," *IEEE Trans. Indust. Informat.*, vol. 14, pp. 5087-5099, 2018.
- [14] B. Durand-Estebe, C. Le Bota, J.N. Mancos, É. Arquis, "Data center optimization using PID regulation in CFD simulations," *Energ. Buildings*, vol.66, pp. 154-164, 2013.
- [15] B. Durand-Estebe, C. Le Bota, J.N. Mancos, É. Arquis, "Simulation

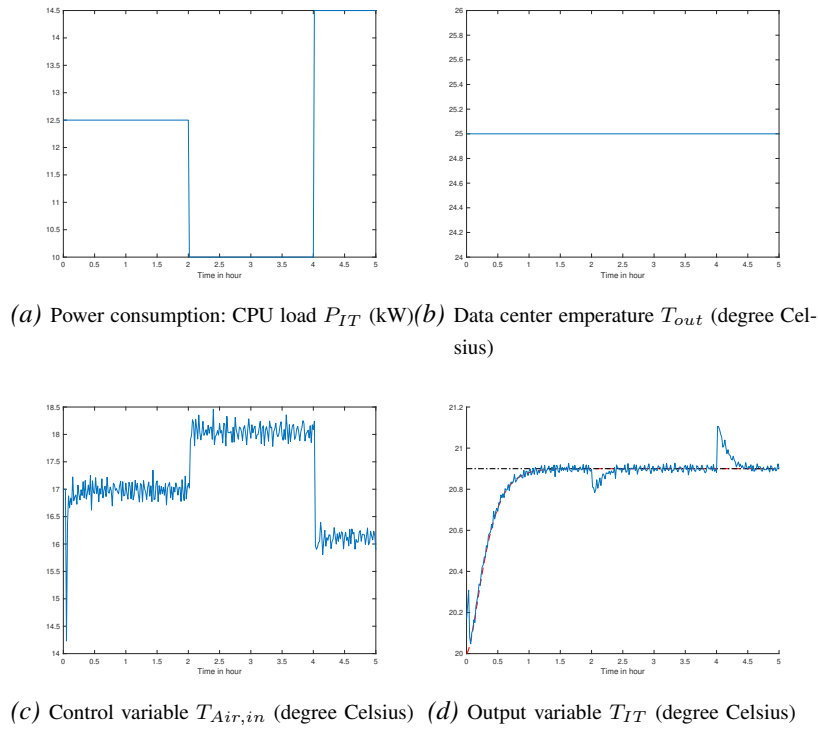

Fig. 3: Sudden CPU load change

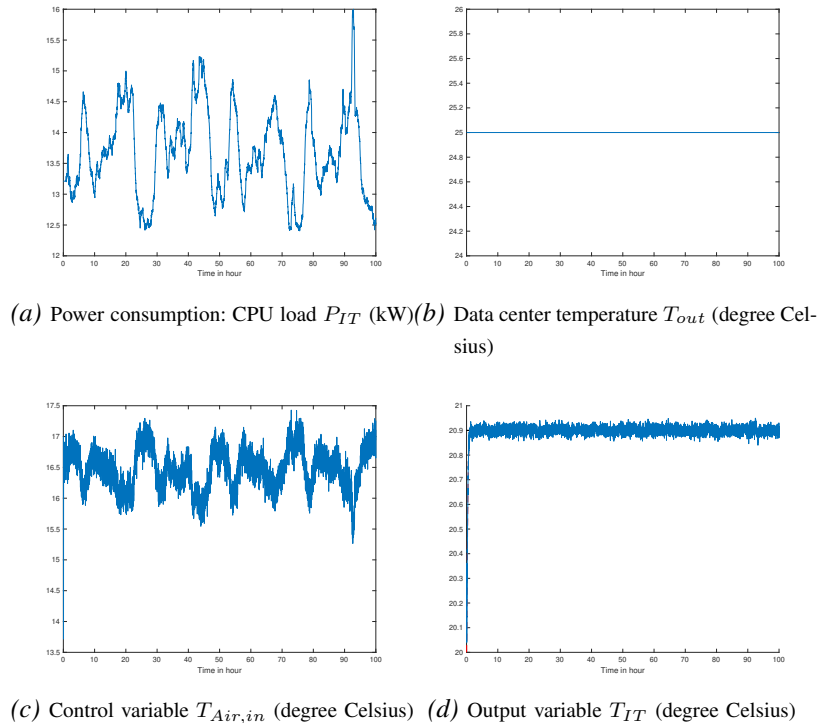

Fig. 4: Realistic CPU load change

of a temperature adaptive control strategy for an IWSE economizer in a data center,” *App. Energ.*, vol. 134, pp. 45-56, 2014.

[16] Q. Fang, J. Wang, Q. Gong, “QoS-driven power management of data centers via model predictive control,” *IEEE Trans. Automat. Sci.*

*Engin.*, vol. 13, pp. 1557-1566, 2016.

[17] M. Fliess, C. Join, “Model-free control,” *Int. J. Contr.* vol. 86, pp. 2228-2252, 2013.

[18] M. Fliess, C. Join, M. Beckheva, A. Moradi, H. Mounier, “Easily

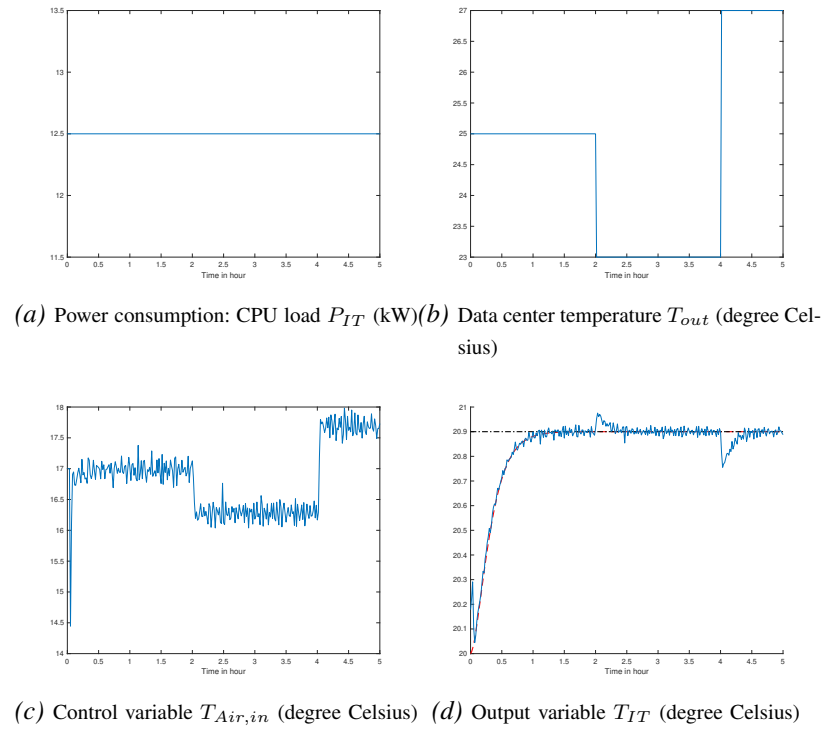

Fig. 5: Sudden temperature change

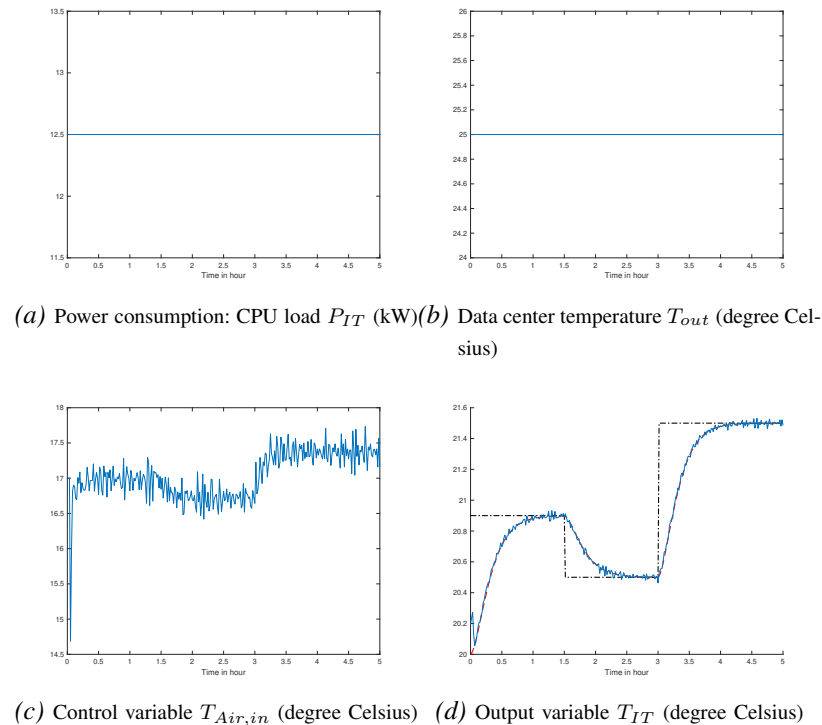
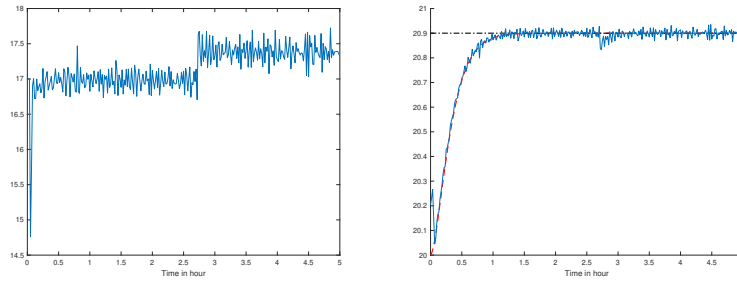

Fig. 6: Another reference trajectory

implementable time series forecasting techniques for resource provisioning in cloud computing,” 6th Int. Conf. Contr. Decis. Informat. Techno., Paris, 2019. <https://hal.archives-ouvertes.fr/hal-02024835/en/>

for continuous-time linear systems via new algebraic techniques,” H. Garnier, L. Wang (Eds): Identification of Continuous-time Models from Sampled Data, pp. 362–391, Springer, 2008.



(a) Control variable  $T_{Air,in}$  (degree Celsius) (b) Output variable  $T_{IT}$  (degree Celsius)

Fig. 7: Parameters change:  $\times 1.5$

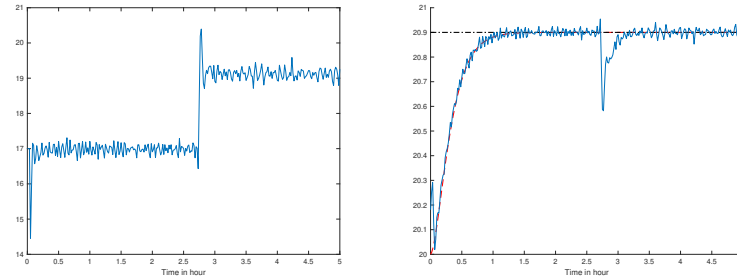

(a) Control variable  $T_{Air,in}$  (degree Celsius) (b) Output variable  $T_{IT}$  (degree Celsius)

Fig. 8: Parameter change:  $\times 0.5$

- short-term time series forecasting techniques,” *Solar Energ.*, vol. 166, pp. 519-528, 2018.
- [21] Y. Fu, W. Zuo, M. Wetter, J.W. VanGilder, X. Han, D. Plamondon, “Equation-based object-oriented modeling and simulation for data center cooling: A case study,” *Ener. Build.*, vol. 186, pp. 108-125, 2019.
- [22] K. Hamiche, M. Fliess, C. Join, H. Abouaïssa, “Bullwhip effect attenuation in supply chain management via control-theoretic tools and short-term forecasts: A preliminary study with an application to perishable inventories,” 6th Int. Conf. Contr. Decis. Informat. Techno., Paris, 2019. <https://hal.archives-ouvertes.fr/hal-02050480/en/>
- [23] J.L. Hellerstein, Y. Diao, S. Parekh, D.M. Tilbury, *Feedback Control of Computing Systems*, Wiley, 2004.
- [24] N. Horner, I. Azevedo, “Power usage effectiveness in data centers: overloaded and underachieving,” *Electr. J.*, vol. 29, pp. 61-69, 2016.
- [25] P.K. Janert, *Feedback Control for Computer Systems*, O’Reilly Media, 2014.
- [26] T. Jiang, L. Yu, Y. Cao, *Energy Management of Internet Data Centers in Smart Grid*, Springer, 2015.
- [27] N. Jones, “How to stop data centres from gobbling up the world’s electricity,” *Nature*, vol. 561, pp. 163-168, 2018.
- [28] Y. Joshi, P. Kumar (Eds), *Energy Efficient Thermal Management of Data Centers*, Springer, 2012.
- [29] J. Khazaii, *Energy-Efficient HVAC Design*, Springer, 2014.
- [30] F. Lafont, J.-F. Balmat, N. Pessel, M. Fliess, “A model-free control strategy for an experimental greenhouse with an application to fault accommodation,” *Comput. Electron. Agricul.*, 110, pp. 139-149, 2015.
- [31] N. Lasic, T. Lu, C. Boutilier, M. Ryu, E. Wong, B. Roy, G. Imwalle, “Data center cooling using model-predictive control,” 32nd Conf. Neural Inform. Process. Syst. (NeurIPS), Montréal, 2018.
- [32] C. Lee, R. Chen, “Optimal self-tuning PID controller based on low power consumption for a server fan cooling system,” *Sensors*, vol. 15, 11685-11700, 2015.;
- [33] I.T. Michailidis, T. Schild, R. Sangi, P. Michailidis, C. Korkas, J. Fütterer, Dirk Müller, E.B. Kosmatopoulos, “Energy-efficient HVAC management using cooperative, self-trained, control agents: A real-life German building case study,” *App. Ener.*, vol. 211, pp. 113-125, 2018.
- [34] E. Pakbaznia, M. Pedram, “Minimizing data center cooling and server power costs,” *ACM/IEEE Int. Symp. Low Power Electron. Design*, San Francisco, 2009.
- [35] L. Parolini, B. Sinopoli, B.H. Krogh, Z. Wang, “A cyber-physical systems approach to data center modeling and control,” *Proc. IEEE*, vol. 100, pp. 254-268, 2012. for Energy Efficiency
- [36] D. Paul, W.-D. Zhong, S.K. Bose, “Demand response in data centers through energy-efficient scheduling and simple incentivization,” *IEEE Syst. J.*, vol. 11, pp. 613-624, 2017.
- [37] B. Qureshi, “Profile-based power-aware workflow scheduling framework for energy-efficient data centers,” *Future Generat. Comput. Syst.*, vol. 94, pp. 453-467, 2019.
- [38] H. Rong, H. Zhang, S. Xiao, C. Li, C. Hu, “Optimizing energy consumption for data centers,” *Renew. Sustain. Energ. Rev.*, vol. 58, pp. 674-691, 2018.
- [39] B. Telsang, S. Djouadi, M. Olama, T. Kuruganti, J. Dong, Y. Xue, Model-free control of building HVAC systems to accommodate solar photovoltaic energy, *IEEE Int. Symp. Power Electron. Distribut. Generat. Syst. (PEDG)*, Charlotte, NC, 2018.
- [40] F. Terraneo, A. Leva, W. Fornaciari, “Event-Based Thermal Control for High Power Density Microprocessors,” W. Fornaciari, D. Soudris (Eds): *Harnessing Performance Variability in Embedded and High-performance Many/Multi-core Platforms*, pp. 107-127, Springer, 2019.
- [41] J. Yao, X. Liu, C. Zhang, “Predictive electricity cost minimization through energy buffering in data centers,” *IEEE Trans. Smart Grid*, vol. 5, pp. 230-238, 2014.
- [42] K. Yosida, *Operational Calculus* (translated from the Japanese), Springer, 1984.
- [43] J. Wang, Q. Zhang, S. Yoon, Y. Yu, “Impact of uncertainties on the supervisory control performance of a hybrid cooling system in data center,” *Building Environ.*, vol. 148, pp. 361-371, 2019.
- [44] C. Wu, R. Buyya, *Cloud Data Centers and Cost Modeling*, Morgan Kaufmann, 2015.
- [45] R. Zhou, Z. Wang, C.E. Bash, A. McReynolds, C. Hoover, R. Shih, N. Kumari, R.K. Sharma, “A holistic and optimal approach for data center cooling management,” *Amer. Contr. Conf.*, San Francisco, 2011.